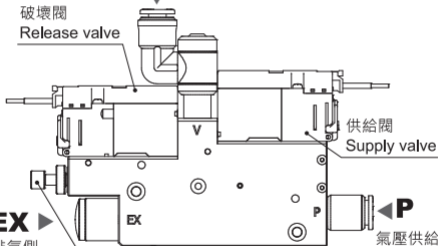

**KGN****VB08**真空單元  
VACUUM UNIT**V** 真空側 Vacuum port

▼ Ø4真空過濾器 Ø4 Vacuum suction filters

破壞閥

Release valve

**EX**

排氣側

Exhaust port

破壞流量調整針閥

Vacuum break flow adjustment needle

供給閥

Supply valve

氣壓供給側

Air supply port

M5X0.8

## 迴路圖 Circuit configurations

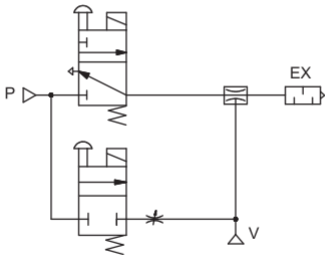

<http://www.kgn.com.tw> E-mail: [service@kgn.com.tw](mailto:service@kgn.com.tw)



HE006-1-201907

# VA / VB / VC 壓力計使用說明書

## 1. 產品內容清單

本體 .....	1PC
電源線 2M(VSL-2M).....	1PC
說明書 .....	本冊

## 2. 注意事項

	請勿使用於液體或腐蝕性氣體
	避免使用於有水氣、油氣、灰塵、高溫、多濕的場所。 嚴禁於爆炸性、易燃性氣體，及需要防爆的場合使用本產品。
	本產品嚴禁撞擊或高處掉落。
	請關閉電源後，再連接電路控制系統，避免損壞。
	請注意電壓的變化，不可超出額定範圍
	請注意本產品的耐壓範圍，如超出壓力範圍，可能導致危險或功能異常。
	本壓力開關為 CE 認證品，但不具有耐雷擊性，對於雷擊突波的保護措施，請依裝置側採取其他保護對策。
	請勿將本產品電源導線與其他高壓線並行，以避免感應而產生誤動作。

## 3. 規格表

額定壓力值	10 ~ -100 KPa
設定壓力值	0 ~ -100 KPa
耐壓力	300 KPa
適用氣體	空氣，非腐蝕性，不可燃性
顯示設定	單位：kgf/cm <sup>2</sup> 、MPa、KPa、bar、inHg、psi 顯示休眠：☺
電源電壓	DC 12~24V ±10%
消費電流	≤ 30mA
開關輸出	NPN 輸出
輸出動作	常開 NO / 常關 NC
輸出模式	單點模式 / 遲滯模式 / 窗型比較模式
反應時間	2ms、20ms、100ms、250ms、500ms、1sec、2sec
最大負載電流	50mA
最大供應電壓	DC 30V
應差	可調 1~9 KPa
表示精度	±2% F.S.
密碼鎖	有 Yes
多機複製	有 Yes
語言選擇	中文 / 英文
動作指示燈	綠燈：電源，紅燈：輸出指示
周圍溫度範圍	動作：0~50°C，保存：-10~60°C (無水露及不結水情況)
周圍濕度範圍	作動及保存：35~85% RH (無水露)
標準配件	電源線 (VSL-2M) 長度 Length：2M
重量	40g

## 4. 外觀·構造

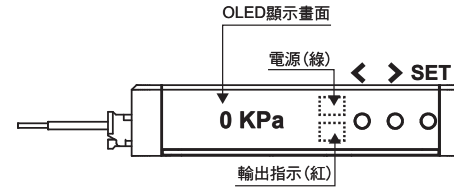

VSL-2M 電源線	PIN	顏色	說明
	#1	紅	DC(+)
	#2	白	OUTPUT
	#3	綠	COPY
	#4	黑	DC(-)

## 5. 接線範例

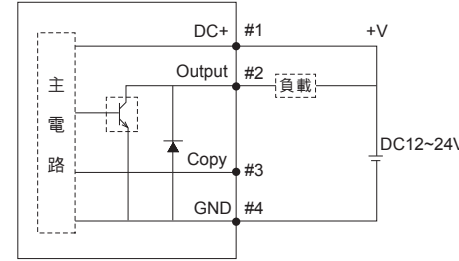

## 6. 輸出模式

(1) 單點輸出模式：

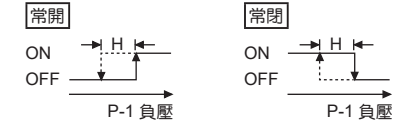

(2) 遲滯模式：



(3) 窗型比較模式：

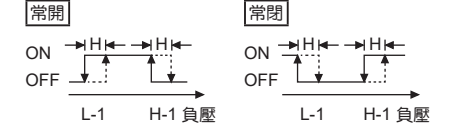

## 7. 功能列表

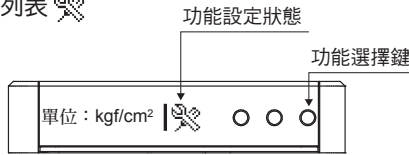

OLED	功能設定	項目或數值	● 項目 ○ 數值
單位	單位顯示	kgf/cm <sup>2</sup> MPa KPa bar inHg psi	●
	輸出警報開關	常開、常關	●
	3 組輸出模式	單點、遲滯、比較	●
單點	單點壓力值	0~-100 (KPa)	○
下限	下限壓力值	0~-100 (KPa)	○
上限	上限壓力值	0~-100 (KPa)	○
反應差	應差值 (±KPa)	1   2   3   4   5   6   7   8   9	●
	7 組反應時間	2ms 20ms 100ms 250ms 500ms 1sec 2sec	●
	數字密碼鎖	0001~9999	○
	多機複製	主機、子機	●
	語言選擇	中文、En	●

★ 單點壓力值：限「單點」模式 (參考 6.)，若設定範圍超過以 -100 輸出。  
★ 上限、下限壓力值：限「遲滯」、「比較」模式，系統會切換為正確數值。若設定範圍超過以 -100 輸出。(參考 6.)

## 8. 操作方法

### 8-1. 主畫面

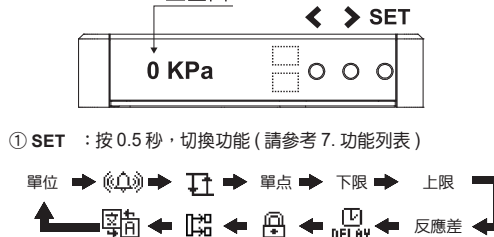

① SET：按 0.5 秒，切換功能 (請參考 7. 功能列表)



② <和>：同時按下，壓力歸零

### 8-2. 項目選擇

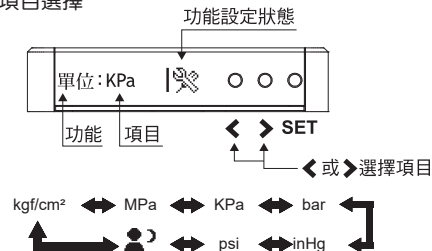

※「顯示休眠」時，按 SET 啟動「功能設定」

### 8-3. 數值設定

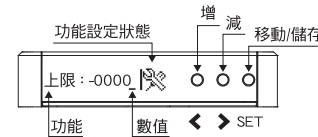

Step1. <(增)>或>(減)，設定數值

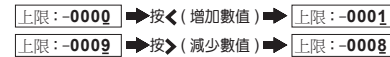

Step2. 位移設定：SET 按 1 秒，移動位數 (底線)

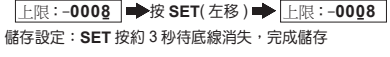

Step3. 儲存設定：SET 按約 3 秒待底線消失，完成儲存



### 8-4. 密碼鎖設定

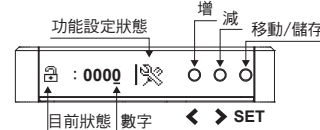

Step1. <(增)>或>(減)，設定數字



Step2. 位移設定：SET 按 1 秒，移動位數 (底線)



Step3. 儲存設定：SET 按約 3 秒，圖示「上鎖」完成儲存



### 8-5. 多機複製設定

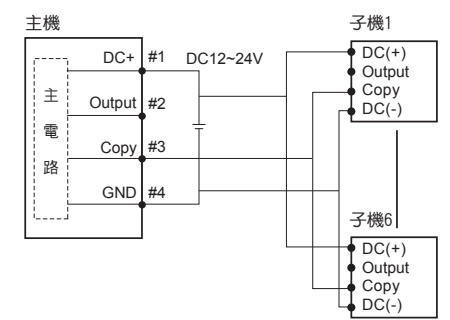

Step1. 使用前，先關閉電源。

Step2. 接線完畢，再同步開啟電源。

Step3. 設定 1 台為「主機」(預設為子機)



Step4. 主機傳送：SET 按約 3 秒，直到「主機」反白傳送完成後放開



Step5. 子機接收：

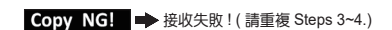

# VA / VB / VC Pressure switch Instruction Manual

## 1. Product list

Body.....	1PC
Cable 2M(VSL-2M).....	1PC
Instruction manual.....	This

## 2. Cautions

- Do not use liquid or corrosive gas with this product.
- Try to avoid locations with abundant of steam, oil vapor, dust, and high temperature and high humidity. This product shall not be used at locations where explosion-proof is required.
- Do not drop, hit or allow excessive
- Turn power off before connecting wiring.
- Do not exceed the specified maximum allowable load.
- Please use with in the rating pressure range. Otherwise it can cause damage or shorten the lifetime of the Pressure switch.
- The product is CE marked, but not immune to lightning strikes. Take measures against lightning strikes in the device.
- Avoid placing the COPY line next to power cable and high voltage cable. Prevent the COPY line from generating abnormal signals.

## 3. Specifications

Rated pressure range	10 ~ -100 kPa
Setting pressure range	0 ~ -100 kPa
Withstand pressure	300 KPa
Fluid	Air, Non-corrosive / Non-flammable gas
Display selection	Unit : kgf/cm <sup>2</sup> · MPa · KPa · bar · inHg · psi Display saving :
Power supply voltage	DC 12~24V ±10%
Current consumption	≤ 30mA
Switch output	NPN transistor
Output operation	NO / NC
Operating mode	One point mode/ Hysteresis mode / Window comparator mode
Response time	2ms · 20ms · 100ms · 250ms · 500ms · 1s · 2s
Maximum load current	50mA
Maximum applied voltage	DC 30V
Hysteresis	Adjustable 1~9 KPa
Indicator accuracy	±2% F.S.
Lock password	Yes
Copy function	Yes
Language selection	Chinese/English
Indicator LED	Green : Power · Red : Output indicator
Ambient temperature range	Operation:0~50°C, Storage:-10~60°C (No condensation or freezing)
Ambient humidity range	Operation/Storage: 35 ~ 85% RH (with no condensation)
Accessories	Cable (VSL-2M) Length : 2M
Weight	40g

## 4. Appearance and Construction

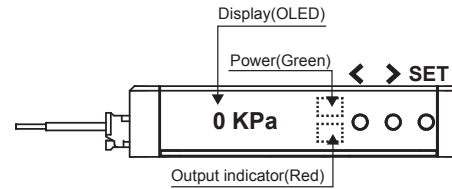

VSL-2M Cable	PIN	Color	Description
	#1	Red	DC(+)
	#2	White	OUTPUT
	#3	Green	COPY
	#4	Black	DC(-)

## 5. Description of Wiring

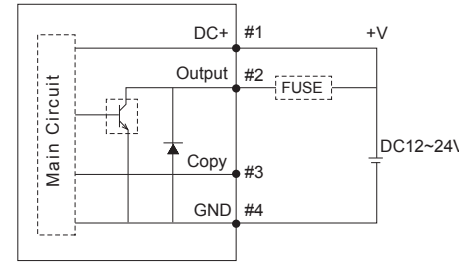

## 6. Output mode

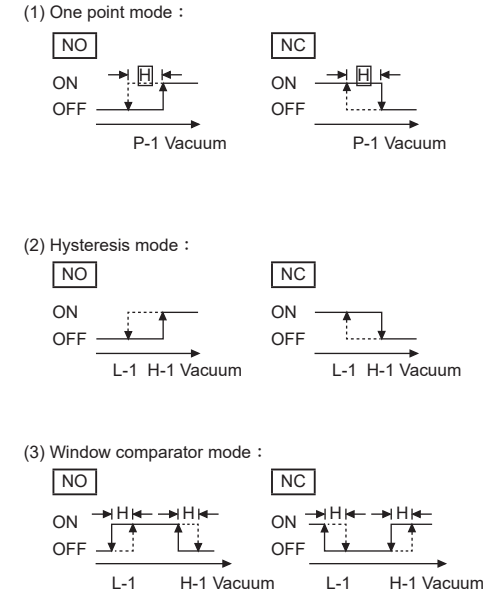

## 7. Function list

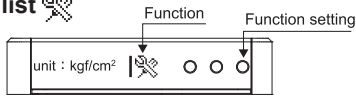

OLED	Function	Item or Digital	Item or Digital
unit	Unit selection	kgf/cm <sup>2</sup> MPa KPa bar	●
	Alarm output	NO NC	●
	Operating mode	One point Hyster-esis Comparator	●
OP	One point pressure set(KPa)	0~-100	○
LO	Lower limit pressure set(KPa)	0~-100	○
HI	Upper limit pressure set(KPa)	0~-100	○
Value	Hysteresis(±KPa)	1   2   3   4   5   6   7   8   9	●
	Response time	2ms 20ms 100ms 250ms 500ms 1sec 2sec	●
	Lock password	0001-9999	○
	Copy function	Master Slave	●
	Language selection	Chinese English	●

★ One point pressure set : Only 「one point」 mode(as per 6) · If the setting range exceeds -100 output.  
★ Upper and lower limits pressure set : In 「hysteresis」 and 「window comparator」 mode · If the setting range exceeds -100 output.If the setting different digital. The system switches to the correct digital.(as per 6)

## 8. Operating Method

### 8-1. Home screen

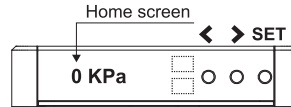

- ① **SET** : Press 0.5 second · Shift the functional items (refer 7.Function list)
- unit → → → OP → LO → HI
- ② **< and >** : Press **<** and **>** at the same time · return-to-zero

### 8-2. Item selection

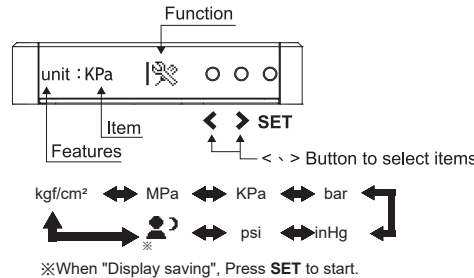

### 8-3. Digital set

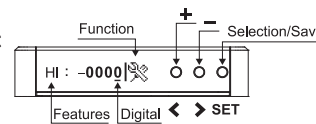

- Step1. **< (+) or > (-)** · Set digital.
- HI : -0000 → Press the **< (+)** → HI : -0001  
HI : -0009 → Press the **> (-)** → HI : -0008
- Step2. Press the **SET** button for one second unit of digital items to move
- HI : -0008 → Press the **SET** button (move left) → HI : -0008
- Step3. Press the **SET** for about 3 seconds the icon lock to save complet.
- HI : -0088 → Press **SET** → HI : -0088

### 8-4. Lock set

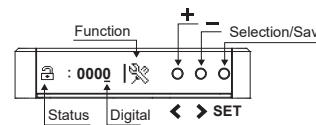

- Step1. **< (+) or > (-)** · Set digital
- : 0000 → Press the **< (+)** → : 0001  
 : 0009 → Press the **> (-)** → : 0008
- Step2. Press the **SET** button for one second unit of digital items to move
- : 0008 → Press the **SET** button (move left) → : 0008
- Step3. Press **SET** for about 3 seconds the icon lock to save complet.
- : 0088 → Press **SET** → : 0088

### 8-5. Copy function

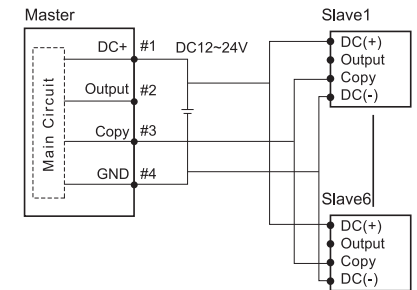

- Step1. Turn off the power before copy function.
- Step2. Synchronously turn on the power after multi-machine wiring is completed.
- Step3. Set a device is the 「master」 (default is the slave)
- : Slave → Press the **< or >** → : Master
- Step4. Master transfer: Press SET for about 3 seconds, until the reverse of the 「Master」 screen display represents the completion of the transfer.
- : Master → Press the **SET** → : Master → : Master
- Step5. Slave receive :
- : Copy OK! → Received successfully!  
 : Copy NG! → failed! (Repeat Steps 3~4.)